

PHANTEKS

GLACIER ONE

HIGH PERFORMANCE CLOSED LOOP CPU LIQUID COOLER

1. Package Contents

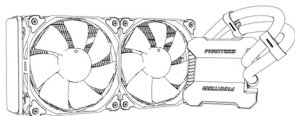

GLACIER ONE 240 MP

- Infinity Mirror Cap
- 240 Radiator
- 2x 120mm MP Fans

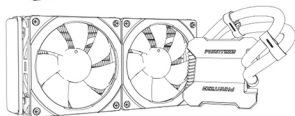

GLACIER ONE 240 MPH

- Infinity Mirror Cap
- 240 Radiator
- 2x 120mm MP Fans
- 2x D-RGB Halos Fan Frames

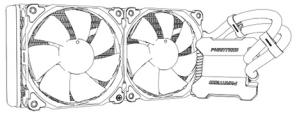

GLACIER ONE 280 MP

- Infinity Mirror Cap
- 280 Radiator
- 2x 140mm MP Fans

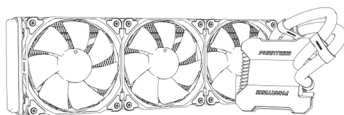

GLACIER ONE 360 MP

- Infinity Mirror Cap
- 360 Radiator
- 3x 120mm MP Fans

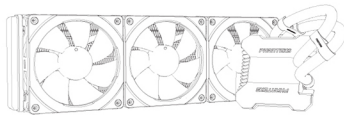

GLACIER ONE 360 MPH

- Infinity Mirror Cap
- 360 Radiator
- 3x 120mm MP Fans
- 3x D-RGB Halos Fan Frames

Accessories (for all models)

4-Pin PWM Splitter Cable, 2x 80mm	
4-Pin Fan PWM Extension Cable, 500mm	
3-Pin D-RGB Motherboard Adapter, 600mm	
PH-NDC Thermal Compound	
3x Tube Clips	
Intel 115x/1200/1366 Backplate	
AMD AM4 Bracket (Intel Bracket is pre-installed)	

Screws:

4x AM4 Stand-off	
4x 115x/1200 Stand-off	
4x 2066 Stand-off	
4x Thumb Nut	
8x/12x 34mm Halos Screws (MPH models only)	
8x/12x 31mm Fan Screws	
8x/12x 5mm Radiator Screws	
8x/12x Washers	

PHANTEKS

2. Motherboard preparation (follow instructions for the corresponding socket)

AMD Socket AM4

4 x



A) Remove the stock mounting brackets

B) Secure the 4x AM4 Stand-offs to the motherboard

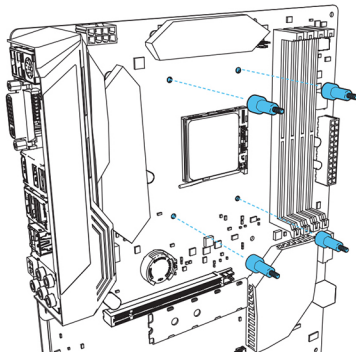
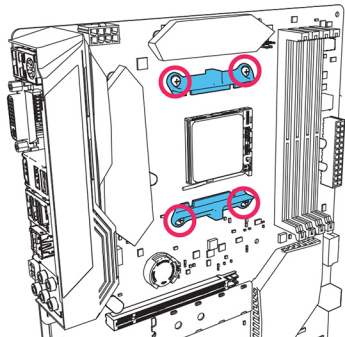

INTEL Socket 115X / 1200 / 1366

4 x



A) Prepare the Intel Backplate for the correct socket

B) Secure the 4x 115x/1200/1366 Stand-offs to the motherboard and Intel Backplate

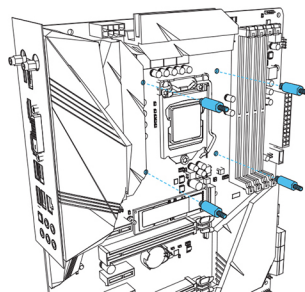
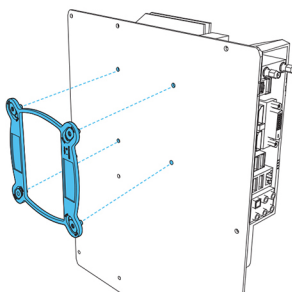
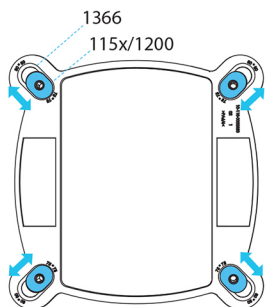

INTEL Socket 2011 & 2066

4 x



A) Secure the 4x Intel 2011/2066 Stand-offs to the motherboard

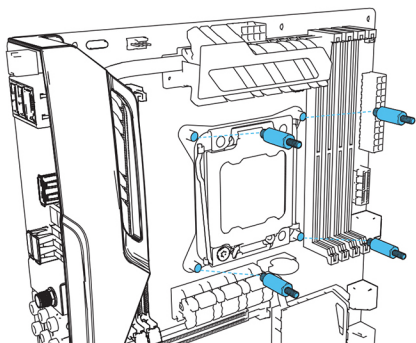

3. Installing the pump block

A) This step is for **AMD AM4 socket only**
(for Intel socket installation, go to step 3B)

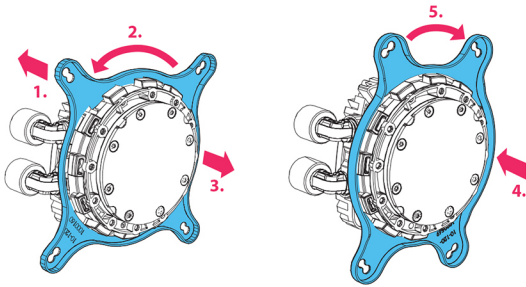

Remove the Intel bracket from the pump

1. Push the Intel bracket in
2. Rotate to loosen
3. pull the bracket off

Secure the AMD AM4 Bracket to the pump

4. push the AMD bracket in
5. rotate to fasten the bracket

B) Secure the pump unit to the stand-offs on the motherboard with the 4x Thumb Nuts

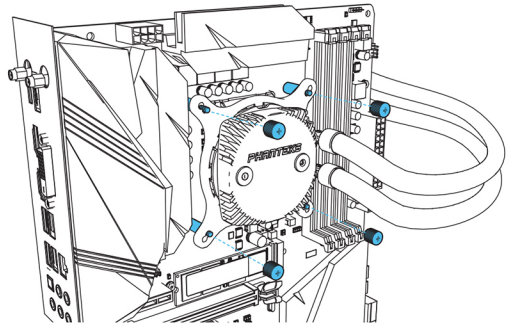

The thermal compound is pre-applied. More thermal compound is included for future installations



4. Mount the radiator and fans

We recommend to install the fans to the radiator before mounting it into the chassis.

3 Types of screws are included to mount the radiator and the fans in different options:

Use the **5mm radiator screw** to mount the radiator directly to the chassis

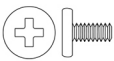

Use the **31mm fan screw** to mount the fan to the radiator (and chassis)

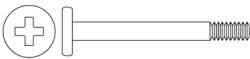

Use the **34mm Halos screw** to mount the Halos and fans to the radiator (and chassis)



Use the optional **washers** if necessary on the chassis for a secure fit



Option A:

5mm radiator screw



31mm fan screw

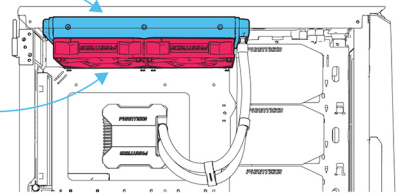

Option B:

31mm fan screw

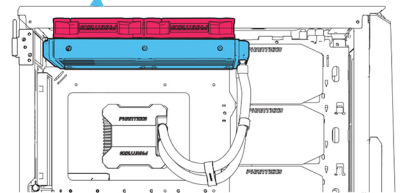

Option C (MPH models only):

5mm radiator screw



34mm Halos screw

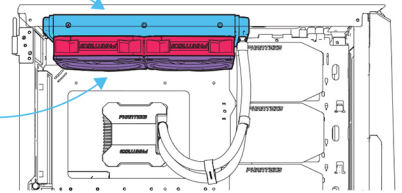

5. Install Infinity Mirror Cap and Tube Clips

A) The Infinity Mirror Cap simply snaps into place via strong magnets. Make sure the D-RGB cable stays clear from the Thumb Nut.

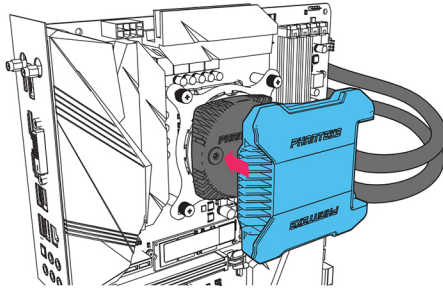

B) OPTIONAL: Install the (3x) included Tube Clips for a tidy tube routing. Simply snap the clips on the tubes.



3 x



Fan cables can be routed through the middle of the Tube Clips

6. Connect cables

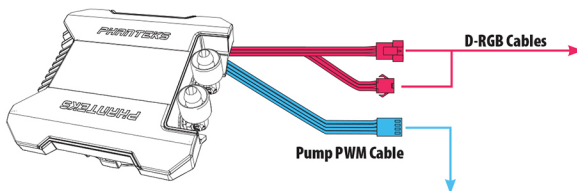

D-RGB cable connection

The D-RGB lighting can be controlled through a D-RGB equipped Phanteks chassis/controller or motherboard.

A) To Phanteks D-RGB Chassis/Controller

Connect the chassis D-RGB connector to the Infinity Mirror Cap and/or Halos.



B) To D-RGB Motherboard

Use the 3-Pin D-RGB Motherboard Adapter to connect the D-RGB cable to a D-RGB equipped motherboard (A-RGB*).

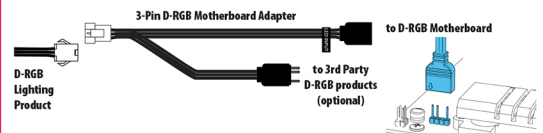

*follow motherboard manual for instruction on D-RGB control

To D-RGB Lighting Products

All Phanteks D-RGB lighting products can be daisy-chained together



Pump & Fan cables

A) Connect the Fans together with the Daisy-chain cables and use the Fan PWM Extension Cable to reach the motherboard.

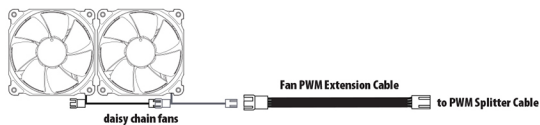

Choose between 2 configurations:

B1) Use the PWM Splitter Cable to connect the pump and fans to a single motherboard CPU header.



B2) If 2x CPU headers are available on the motherboard, the pump and fans can also be connected individually (without PWM Splitter Cable) for more precise control.

7. Support & Warranty

As a Phanteks customer, you are priority number one. We have a dedicated team of employees across the globe to deliver the experience you deserve.

CUSTOMER CARE

RMA AND TECHNICAL SUPPORT AMERICAS

Hours : Monday-Friday 9:00-5:00 PST

Phone number : +1(909)598-2115

Email : support@phanteksusa.com

Facebook : @Phanteks

RMA AND TECHNICAL SUPPORT INTERNATIONAL

Email : support@phanteks.com

Facebook : @Phanteks

For spare parts and optional upgrades please visit:

www.axpertec.com (EU) | www.phanteksusa.com (US)

